

## Special anvendelse til bruseløsning



KB/4025



BRISA-160 i  
badeværelse

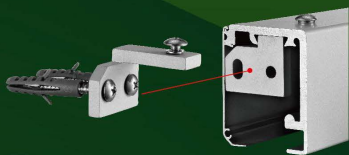
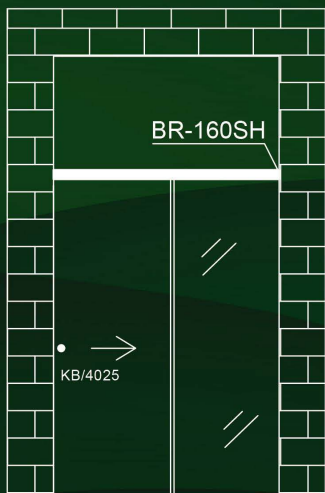

BR-160SH  
Sideholder profil

**Set oppefra (åben)**



**Set oppefra (lukket)**



# BRISA-160 ultra slim

soft stop sliding door system

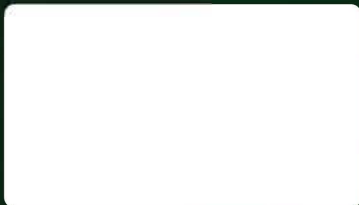



# BRISA-160

GCC®

Ideen bag designet af BRISA-160 systemet var at give brugerne en totalt anderledes oplevelse, når de anvender systemet.

GCC's innovative design sikrer en gnidningsfri og flot skydedør, som også er let at montere på kort tid.

## Tekniske data

- Max. kapacitet: 60 kg
- Til glastykkelser: 8mm og 10mm
- Ultra tynd profil på 50mm x 60mm
- Egner sig til montering på både væg og loft
- Nem justering af højde 4mm
- Skinne og cover fås i MS finish (**mat sølv**)

## Funktioner

- Minimum glasbredde med soft stop funktion i begge ender: 740mm
- Ingen krav til hulboring
- Nem justering af højde 4mm
- Justerbar gulvstyr til glastykkelser af 8mm ~ 12mm

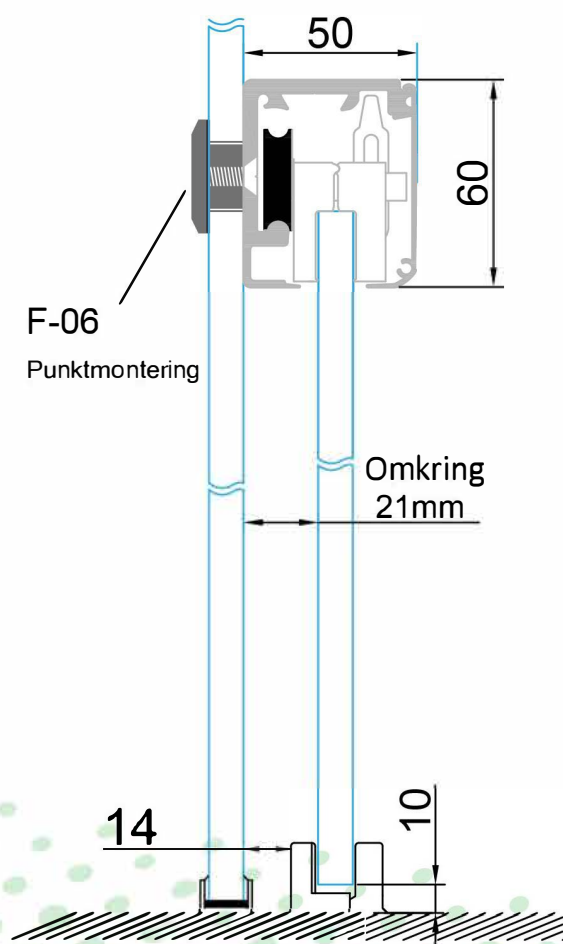

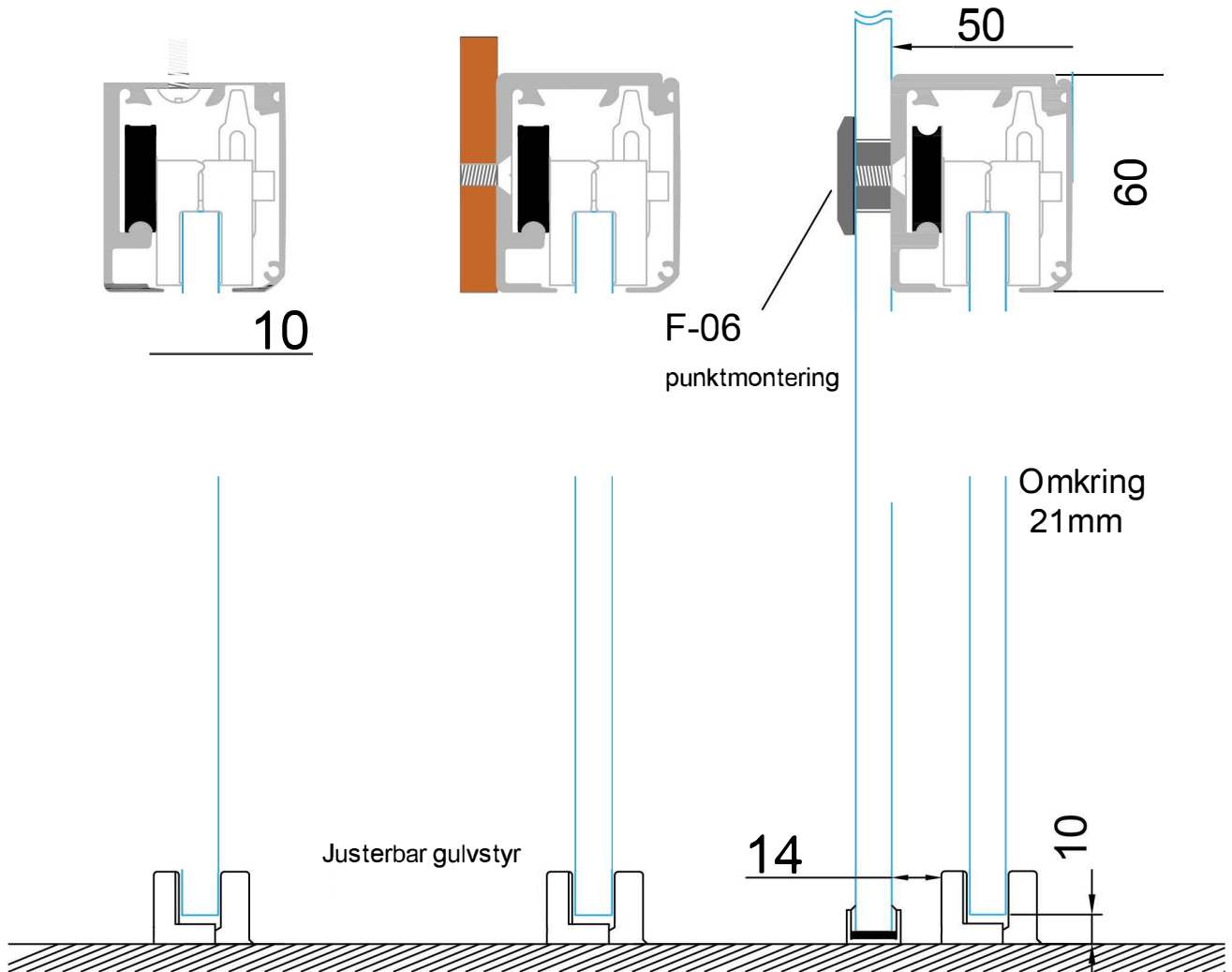

### Tilvalg



CFH-65S  
Skjult håndtag

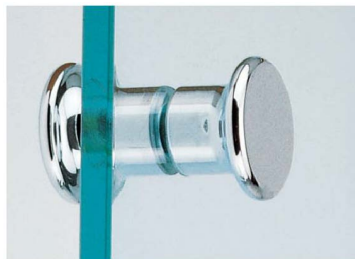

KB/4025  
Dørknop

### Til at lukke mellemrum

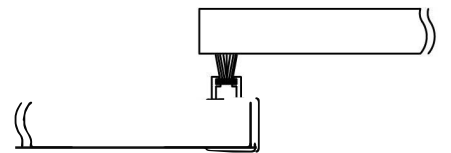

PF-10 "F" Jame

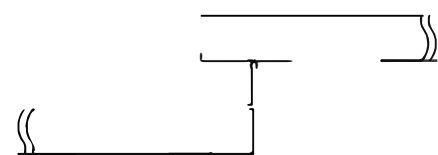

P810 SDJ Side Jame



Pakken inkluderer nedenstående inkl. top skinne og cover



## Klemmer og hjul

Til 8 eller 10 mm glas



## Soft close'ere ( V + H )



## Endestoppere



## Endekapper ( V + H )

Fås i sort som standart



## BG-812 Justerbart gulvstyr

Fås i sort som standart  
(Kan købes separat)





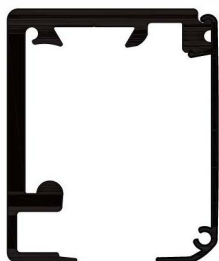

Top skinne og cover er i 2400mm standart længder med mat sølv finish.

### Ekstra tilvalg

#### F-06 punktmontering

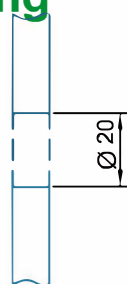

Fladt hul

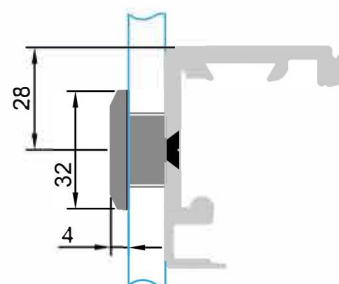

Designet til fastgørelse af det faste panel til hovedskinnen med et fladt hul.

#### C-06 punktmontering

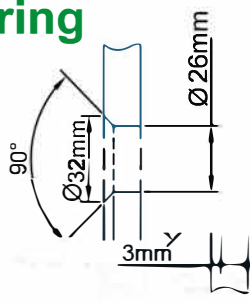

Forsænket hul

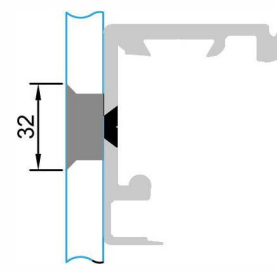

Designet til fastgørelse af det faste panel til hovedskinnen med et forsænket hul

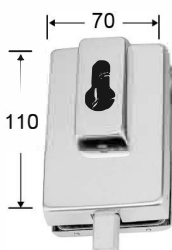

GL-34S



GL-34R



9139



9125



9125ST



9137S

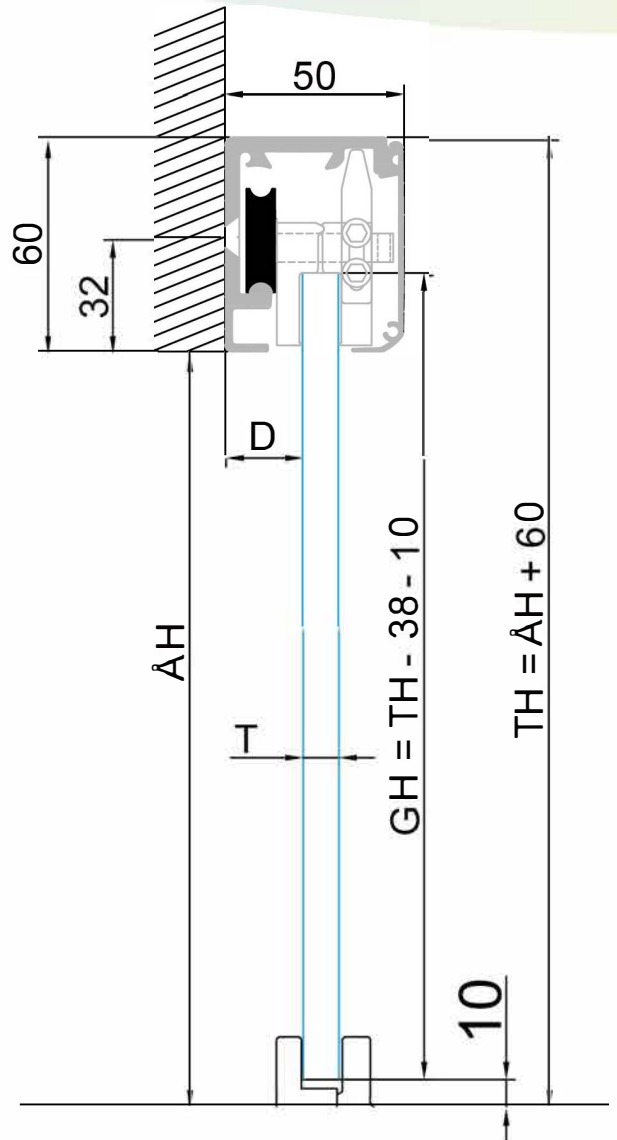
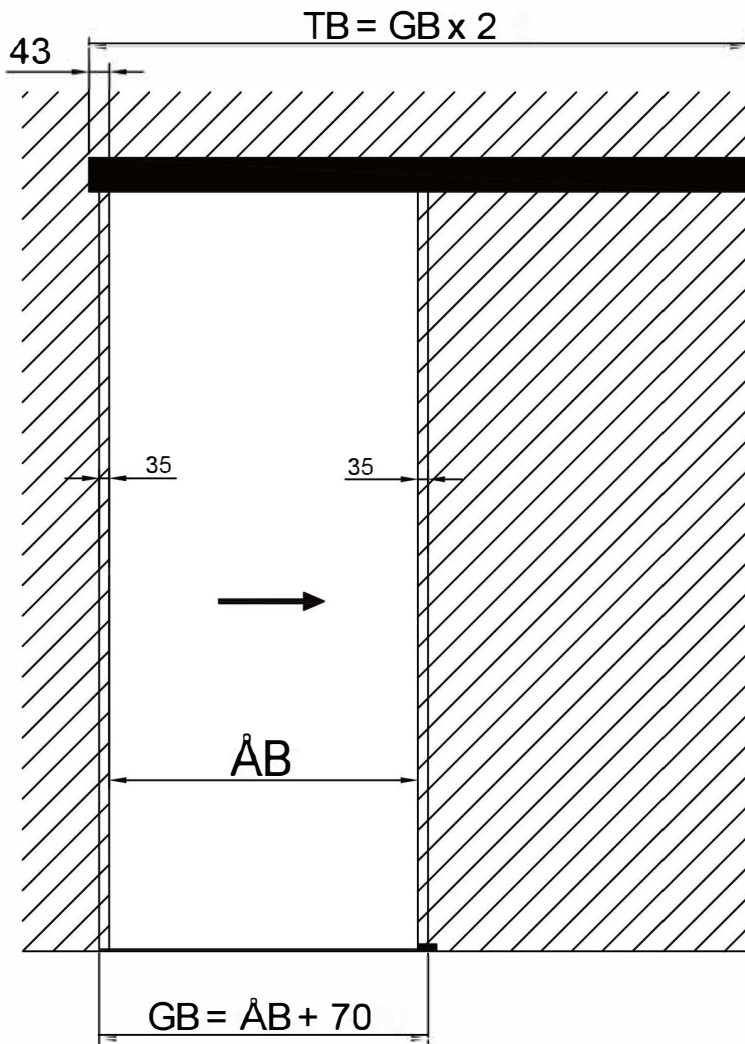

TH : Total højde      TB : Total bredde

ÅH : Åbnings højde

GH : Glas højde

ÅB : Åbnings bredde

GB : Glasbredde

(Min. 740mm med soft stop funktion i begge ender)

T : Glas tykkelse 10mm

B : Luft i bunden (10mm)

D : Distance mellem væg og glas

F : Bredde på fast glas (se næste side)

T	D
8mm	26.5mm
10mm	25.5mm

## Anbefalet værktøj



HW-001  
3 vejs hex skruenøgle

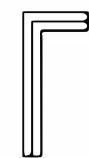

3mm

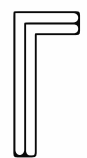

2.5mm

