



## DOWSIL™ 895 Structural Glazing Sealant

One-part silicone sealant

### Features & Benefits

- Meets European standards for structural glazing application, as developed by EOTA
- Excellent adhesion to a wide range of substrates including coated, enameled and reflective glasses and polyester coated aluminum profiles and stainless steel profiles
- Odorless and non-corrosive cure system
- One-part product
- Resistant to ozone
- Excellent stability through wide range of temperatures: -50°C to 150°C
- The cured product exhibits excellent weathering characteristics, and a high resistance to ultra-violet radiation heat and humidity
- High tensile strength makes it ideally suited for structural bonding applications

### Applications

- DOWSIL™ 895 Structural Glazing Sealant is a one-part silicone sealant used for structural glazing.

### Typical Properties

Specification Writers: These values are not intended for use in preparing specifications.

Test <sup>1</sup>	Property	Unit	Result
<b>As supplied</b>			
	Specific gravity		1.43
	Slump or flow	mm	0
	Tack-free time (25°C, 50% R.H.)	minutes	60
	Cure schedule (25°C, 50% R.H.)		
	After 24 hours	mm	2.2
	After 72 hours	mm	3.5
(See also Optimal Glazing Conditions)			
<b>As cured - after 7 days at 25°C and 50% RH</b>			
ASTM D2240	Durometer hardness, Shore A	points	38
ASTM D0412	Ultimate elongation	%	600
ASTM D0412	Tensile strength, at 100% elongation	MPa	0.7

1. ASTM: American Society for Testing and Materials.  
ISO: International Standardization Organization.

## Typical Properties (Cont.)

Test	Property	Unit	Result
ASTM D0412	Tensile strength, at ultimate elongation	MPa	2.85
ASTM D624	Tear strength	kN/m	19
<b>H-piece testing</b>			
ISO 8339	Ultimate elongation	%	260
ISO 8339	Tensile strength	MPa	1.06
ISO 8339	Young modulus	MPa	1.0
	Sealant dynamic design load	Pa	140,000
	Sealant static design load	Pa	7,000
	Service temperature range	°C	-50 to +150
	Working time	minutes	15

### Description

DOWSIL™ 895 Structural Glazing Sealant is a one-part neutral curing silicone sealant designed specifically for the structural bonding of glass, metal, and other building components.

It can also be used to adhere stiffening elements to building panels and for other similar adhesive applications.

Neutral alkoxy cures at room temperature on exposure to water vapor in the air, giving off a small amount of methanol.

### Technical Specifications and Standards

DOWSIL™ 895 Sealant exhibits a high level of physical properties and adhesive performances which are retained even after aging as detailed by EOTA (Ref: INV 96/BE.35).

CE Marked (ETA 01/0005) as structural glazing sealant component according to ETAG002, the European Technical Guidelines for structural glazing with a level of attestation of 1. (external quality audit) valid in all EC countries.

Meets structural glazing sealant requirements according to PrEN13022, SNJF VEC and Vi-VEC.



## Technical Specifications and Standards (Cont.)

Regulation or protocol	Conclusion	Version of regulation or protocol
French VOC régulations	A+	Regulation of March and May 2011 (DEVL1101903D and DEVL1104875A)
French CMR components	Pass	Regulation of April and May 2009 (DEVP0908633A and DEVP0910046A)
Italian CAM Edilizia	Pass	Decree 11 January 2017 (GU n.23 del 28-1-2017)
AgBB/ABG	Pass	Anforderungen an bauliche Anlagen bezoglich des Gesundheitsschutzes (ABG), Entwurf 31.08.2017/August 2018 (AgBB)
Belgian Regulation	Pass	Royal decree of May 2014 (C-2014/24239)
EMICODE	EC1 Plus	April 2019
Indoor Air Comfort	Pass	Indoor Air Comfort 6.0 of February 2017
Indoor Air Comfort GOLD	Pass	Indoor Air Comfort GOLD 6.0 of February 2017
Blue Angel (DE-UZ 123)	Pass	DE-UZ 123 for "Low-Emission Sealants for Interior Use", (January 2019)
BREEAM International	Exemplary lvl	BREEAM International New Construction v2.0 (2016)
BREEAM Norway	Pass	BREEAM-NOR New Construction v1.2 (2019)
CDPH	Pass	
M1	Pass	

### Installation

For structural glazing use, DOWSIL™ 895 Sealant should be factory-applied. Factory application helps ensure optimal sealing conditions and performance. Job-site application should only be carried out for remedial work, or when the glazing design does not allow otherwise.

This adhesive meets European Standard for structural glazing application the EOTA guidelines for SSGS.

### Joint Design

As a general rule, structural sealant joints made with DOWSIL™ 895 Sealant should have a width between 6 mm and 15 mm. However, the exact width is determined by the structural calculations. The width (dimension y) of the structural sealant joint should also be calculated to accommodate thermal and dynamic movements but as a rule should not be less than 6 mm.

### Accessory Selection

The appropriate selection of all accessories such as setting blocks and backing materials is of primary importance in avoiding discoloration or adhesion-related problems due to incompatibility. Dow will also assess the suitability of proposed accessory materials as part of the standard testing services. Closed cell polyethylene foam is the recommended backer material for most joints. Silicone-based setting blocks are generally recommended for best compatibility.

Some typical examples of joint designs are shown in Figures 2–5 on page 6.

## Installation (Cont.)

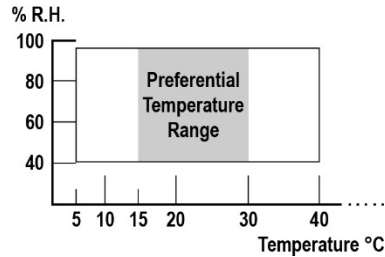
### Optimal Glazing Conditions

Ideally, all glazing should be done in factory and within the following conditions of temperature and humidity:

Temperature conditions: 5°C to 40°C

Humidity conditions: 40% to 95%

Recommended temperatures range: from 15°C to 30°C



**Figure 1:** Humidity cure envelope for DOWSIL™ 895 Sealant.

Any combination of the above conditions will ensure a cure schedule sufficient to allow transportation of the glazed modules within 21 days, depending on joint configuration. Consult technical services for specific advice.

### Preparatory Work

Clean all joints and glazing pockets, removing all contaminants such as grease, oil, dust, water, frost, surface dirt, old sealant, or glazing compounds and protective coatings. Metal, glass and plastic surfaces should be cleaned by mechanical or solvent procedures. Where used, solvent should be wiped on and off with clean, oil and lint free cloths.

### Priming

Priming is not usually required when using DOWSIL™ 895 Sealant. However, it is essential that adhesion be tested prior to use. Specific primer recommendations will be on a project basis. Please contact technical service for further advice.

### Masking and Tooling

Areas adjacent to joints may be masked to ensure a neat sealant line. Do not allow masking tape to touch clean surfaces to which the sealant is to adhere. Tooling should be completed in one continuous stroke within 5 minutes after sealant application. Masking tape should be removed immediately after tooling.

### Application Method

Install the backing material, setting blocks and spacer tapes as specified. Apply DOWSIL™ 895 Sealant in a continuous operation using positive pressure to properly fill and seal the joint. Tool the sealant with slight pressure to spread it against the backing material and the joint surfaces. A tool with a concave profile is recommended to keep the sealant within the joint.

**Maintenance**

No maintenance is needed. If sealant becomes damaged, replace damaged portion.

DOWSIL™ 895 Sealant will adhere to compatible cured silicone sealants which exhibits a clean knife-cut or abraded surface.

**Handling  
Precautions**

PRODUCT SAFETY INFORMATION REQUIRED FOR SAFE USE IS NOT INCLUDED IN THIS DOCUMENT. BEFORE HANDLING, READ PRODUCT AND SAFETY DATA SHEETS AND CONTAINER LABELS FOR SAFE USE, PHYSICAL AND HEALTH HAZARD INFORMATION. THE SAFETY DATA SHEET IS AVAILABLE ON THE DOW WEBSITE AT DOW.COM, OR FROM YOUR DOW SALES APPLICATION ENGINEER, OR DISTRIBUTOR, OR BY CALLING DOW CUSTOMER SERVICE.

**Usable Life and  
Storage**

When stored at or below 30°C in the original unopened containers, DOWSIL™ 895 Structural Glazing Sealant has a usable life of 12 months from the date of production.

**Packaging  
Information**

This product is available in 250 kg drums, 20 liter pails, 310 ml cartridges (12 per box) and 600 ml sausages.

**Limitations**

DOWSIL™ 895 Sealant should not be used for structural applications without the prior written approval of Dow Construction Industry Technical Services Department. Each project should be specifically and separately approved by Dow.

This product is neither tested nor represented as suitable for medical or pharmaceutical uses.

**Health and  
Environmental  
Information**

To support customers in their product safety needs, Dow has an extensive Product Stewardship organization and a team of product safety and regulatory compliance specialists available in each area.

For further information, please see our website, [dow.com](http://dow.com) or consult your local Dow representative.

**Disposal  
Considerations**

Dispose in accordance with all local, state (provincial) and federal regulations. Empty containers may contain hazardous residues. This material and its container must be disposed in a safe and legal manner.

It is the user's responsibility to verify that treatment and disposal procedures comply with local, state (provincial) and federal regulations. Contact your Dow Technical Representative for more information.

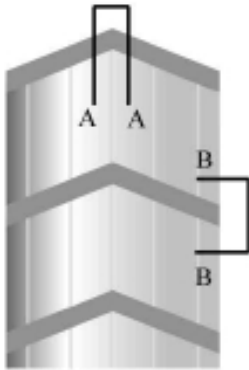
**Product  
Stewardship**

Dow has a fundamental concern for all who make, distribute, and use its products, and for the environment in which we live. This concern is the basis for our product stewardship philosophy by which we assess the safety, health, and environmental information on our products and then take appropriate steps to protect employee and public health and our environment. The success of our product stewardship program rests with each and every individual involved with Dow products - from the initial concept and research, to manufacture, use, sale, disposal, and recycle of each product.

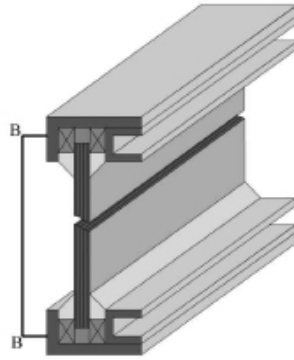
## Customer Notice

Dow strongly encourages its customers to review both their manufacturing processes and their applications of Dow products from the standpoint of human health and environmental quality to ensure that Dow products are not used in ways for which they are not intended or tested. Dow personnel are available to answer your questions and to provide reasonable technical support. Dow product literature, including safety data sheets, should be consulted prior to use of Dow products. Current safety data sheets are available from Dow.

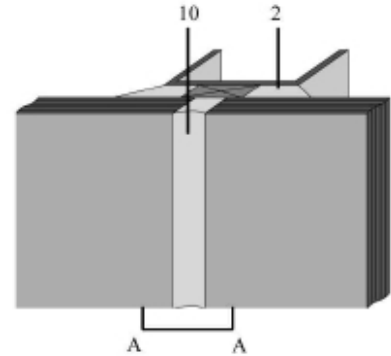
## Typical Examples of Joint Design



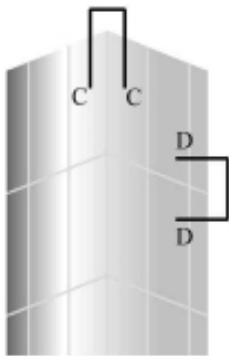
**Figure 2:** System for 2-sided structural glazing.



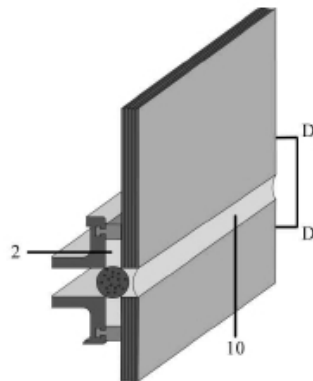
**Figure 2A:** Transom detail.  
Examples of structural glazing designs:  
2-sided design (installed on site).



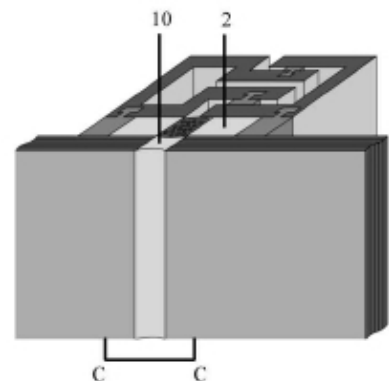
**Figure 2B:** A mullion detail.



**Figure 3:** System for 4-sided structural glazing.

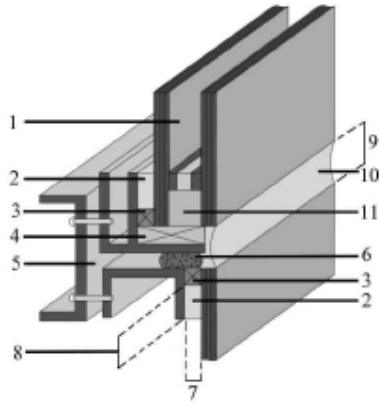


**Figure 3A:** Transom detail.  
Examples of structural glazing designs:  
4-sided design (factory glazed).

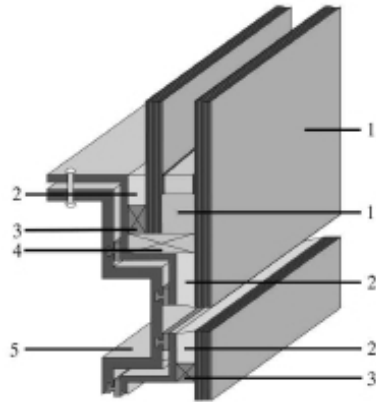


**Figure 3B:** A mullion detail.

## Typical Examples of Joint Design (Cont.)



**Figure 4:** Design with supported insulating glass unit.



**Figure 5:** Design with stepped insulating glass unit.

### Legend:

1. Insulating glass unit
2. Silicone structural seal (DOWSIL™ 895 Structural Glazing Sealant)
3. Silicone sealant spacer block
4. Silicone setting block
5. Aluminum profile
6. Backer rod
7. Structural sealant width
8. Structural sealant bite
9. Weatherseal dimension
10. Silicone weatherseal (DOWSIL™ 791 Silicone Weatherproofing Sealant)
11. Silicone insulating glass seal (DOWSIL™ 3362 Insulating Glass Sealant)

dow.com

**NOTICE:** No freedom from infringement of any patent owned by Dow or others is to be inferred. Because use conditions and applicable laws may differ from one location to another and may change with time, Customer is responsible for determining whether products and the information in this document are appropriate for Customer's use and for ensuring that Customer's workplace and disposal practices are in compliance with applicable laws and other government enactments. The product shown in this literature may not be available for sale and/or available in all geographies where Dow is represented. The claims made may not have been approved for use in all countries. Dow assumes no obligation or liability for the information in this document. References to "Dow" or the "Company" mean the Dow legal entity selling the products to Customer unless otherwise expressly noted. NO WARRANTIES ARE GIVEN; ALL IMPLIED WARRANTIES OF MERCHANTABILITY OR FITNESS FOR A PARTICULAR PURPOSE ARE EXPRESSLY EXCLUDED.

